

## KNUCKLE COUPLER INSTALLATION

- Remove Hook & Loop coupler.
- Clip tab "A" from end of tongue and file smooth.
- Attach USA knuckle coupler "B" with #4 screw (C) provided.

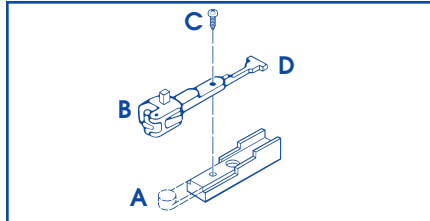

**NOTE:** For operation on 8 foot diameter curved track, the optional coupler box must be used. If snow plow is used, some trimming of the sides around the coupler pocket is necessary.

### OPTIONAL COUPLER BOX ASSEMBLY

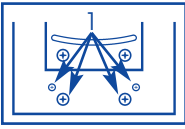

(1) Remove 4 screws that hold coupler support bracket and coupler centering spring. Hook and loop coupler assembly should slide off. Loosen the front two screws holding metal truck guide so you can remove coupler centering spring. Re-tighten two screws holding the metal truck guide.

(2) Mount coupler support bracket provided with coupler box assembly to frame using same screws used for the hook & loop bracket.

(3) Mount coupler box top plate to coupler support bracket provided (1 screw)

(4) Clip rear of knuckle coupler arm off (D prior page)

(5) Mount coupler arm onto slide spring then insert slide spring onto plate making sure coupler is right side up. (thick black coupler release should be facing you)

(6) Attach bottom coupler plate using the two long screws provided.

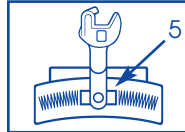
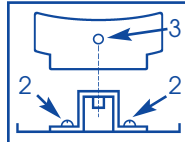

## SERVICING

This Diesel locomotive is built with pride by USA Trains and is covered by a limited warranty. (See limited warranty terms). Please follow these instructions carefully before sending your locomotive for service:

1. Return locomotive in its original blue/red box with the proper foam inserts and then pack the original box in a proper shipping carton so it is well protected in shipment. The package must be fully insured and pre-paid. USA Trains is not responsible for damage or loss during shipment.

2. Include a note explaining the problem and servicing you need performed. Be sure to include your name, street address, (NO P.O. BOXES PLEASE) City, State, Country (if outside U.S.A) and zip code along with a daytime phone number including area code. If the locomotive service is not covered by warranty, a reasonable service fee will be charged. For any locomotives to be returned outside the continental U.S.A., please include \$25.00 U.S. currency to cover return postage. Any locomotives returned in the continental U.S.A. will be reshipped to you pre-paid by USA Trains.

3. Ship your item to:  
USA TRAINS  
662 CROSS STREET  
MALDEN, MA. 02148



## SD40-2 DIESEL LOCOMOTIVE OWNERS MANUAL



USA TRAINS  
662 Cross Street  
MALDEN, MA 02148, USA  
[www.usatrains.com](http://www.usatrains.com)



Dear Customer,

Congratulations on your purchase of this highly detailed replica of the electro-motive (EMD) SD40-2.

The engineering and design staff at USA Trains has spent many hours reviewing original blueprints and developing a locomotive that looks authentic and will provide you with many hours of operating enjoyment all at a reasonable price. Over 400 parts make up this model - the level of detail found in brass locomotives costing thousands of dollars for a fraction of the cost. This locomotive will enhance the appearance of any modelers railroad.

Please read the following instructions which will help you understand and operate the numerous features of this locomotive.

Happy Railroading  
**USA TRAINS**

Happy Railroading  
**USA TRAINS**

## HISTORY OF THE EMD SD40-2

General Motor's Electro-Motive Division first introduced the SD40-2 on January 1, 1972 with the rest of the Dash 2 Line. By December 31, 1978, the SD40-2 was the best selling 6 axle road switcher in history with over 2500 units sold throughout North America. The SD40-2 was popular because it was a dependable 3000 H.P. road switcher that was more economical to keep running than other locomotives in the 3300 to 3600 H.P. range.

The accurate reproduction of this locomotive by USA Trains will allow the modeler to have their favorite railroad SD40-2 running among the other locomotives on his/her railroad.

## FEATURES

- Powerful dual-motored 12 wheel Power Trac drive train
- Operating smoke stack "puffs real smoke"
- Directional red marker lights
- Front & rear directional headlights
- Constant voltage lighting
- Metal handrails
- Interior cab lighting
- Opening cab doors
- Detailed cab interior with engineer and control panel with gauges
- Authentic detailing including diamond plate walkways, grating on steps, window shades, sliding windows and MU connectors
- Expert decoration reproducing authentic paint schemes of your favorite railroad

## MAINTAINING AND SERVICING YOUR SD40-2

### LUBRICATION

Your locomotive was lubricated at the factory and under normal operating conditions will not need to be lubricated during the first 50 hours of operation. The locomotive has three lubrication points.

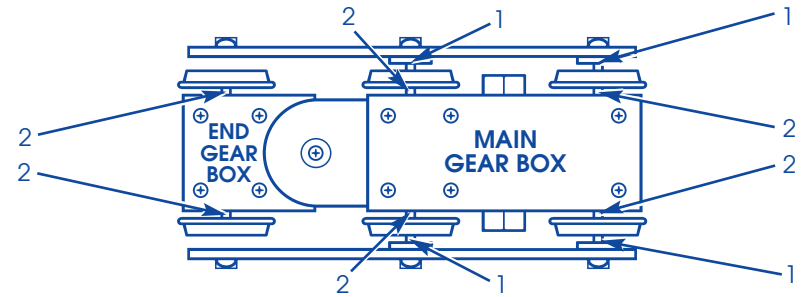

**1. SIDEFRA M JOURNAL BOX:** The axle ends fit into brass bushings which bring power into the locomotive. These brass bushings should periodically be cleaned out and lubricated with a small amount of USA Trains electrically conductive lubricant (USA Trains Part #R50002). Use only our conductive lubricant to avoid loss of electrical contact which could cause your locomotive to lose power or run erratically. The frequency of lubrication depends on your operating conditions.

**2. AXLE LUBRICATION:** Two drops of oil should be placed on all six contact points where the axle enters the gear box. An ultra light oil such as Hob-E-Lube (#HL653) is recommended.

**3. GEAR BOX LUBRICATION:** Under normal operating conditions, the gear box should not have to be lubricated. However, you may want to lubricate the gears after each 100 hours of operation by removing the six screws from the bottom of the main gear box to expose the gears and applying moly grease by Hob-E-Lube to the gears on the axle only. Replace main gear box. Remove 4 screws from end gear box cover and lube. Replace end gear box cover. Do not apply grease to any electrical contacts inside the gear box as you may hinder the electrical contacts required for smooth operation.

### WHEEL/SLIDE SHOES

The SD40-2 units are equipped with twelve electrical pickup points-six per motor truck. Each of these must be cleaned periodically to ensure proper electrical contact with the track which will ensure smooth operation of your locomotive. Clean all six wheels and the bottom surface of the slide shoes periodically to ensure good electrical contact with the track. A good indication that you need to clean these contacts is flickering lights, non-operation of the smoke unit, or a jerking motion of the locomotive.

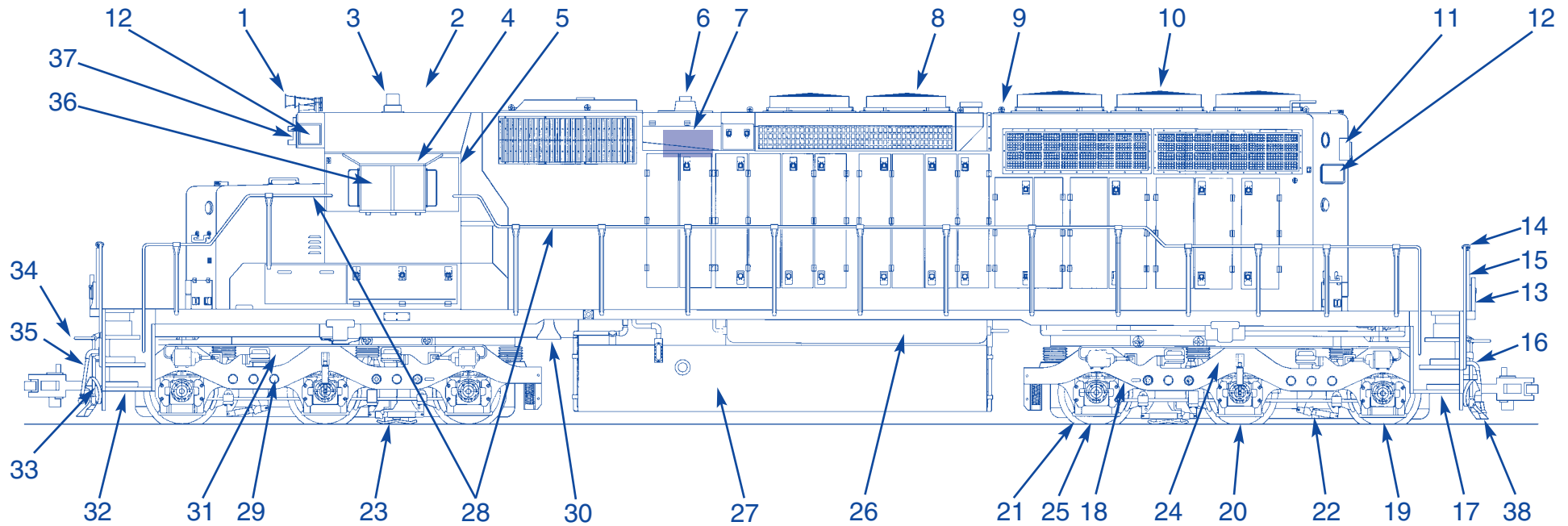

**ITEM No. PART No.**

**DESCRIPTION**

**ITEM No. PART No.**

**DESCRIPTION**

1	R22-401	DIESEL HORN
2	R22-402	ANTENNA
3	R22-403	STROBE LED
4	R22-404	SUNSHADE (specify color)
5	R22-405	WINDSHIELD WIPERS (4)
6	R22-406	SMOKE STACK
7	R22-108	SMOKE UNIT
8	R22-408	LOW ROOF FAN w/ ROTATING BLADE (specify color)
9	R22-409	BRASS LIFT RINGS (12)
10	R22-410	HIGH ROOF FAN w/ ROTATING BLADE (specify color)
11	R22-411	BULB AND WIRE FOR HEADLIGHT (for front or rear)
12	R22-412	NUMBER BOARD - 1 END (specify number & location)
13	R22-413	M.U. CONNECTOR (2) (specify color)
14	R22-414	FRONT/REAR HANDRAILS (2) (specify color)
15	R22-415	FOLD DOWN END STEP (2) (specify color)
16	R22-416	COUPLER SPRING AND MOUNTING PLATE
17	R22-417	END STEPS (6) - ONE END (specify color)
18	R22-418	TRUCK SIDE FRAME SPRINGS (8)
19	R22-419	METAL WHEELS w/ GEAR FOR END GEAR BOX (2)
20	R22-420	METAL WHEELS w/ GEAR FOR CENTER AXLE (2)

21	R22-421	TRACTION WHEELS w/ RUBBER TIRES FOR INNER AXLE
22	R22-422	REPLACEMENT MOTOR TRUCK (1)
23	R22-122	SLIDE SHOES & SPRINGS (4)
24	R22-424	TRUCK SIDE FRAMES (2) (specify color)
25	R22-425	RUBBER TIRES (4)
26	R22-426	CYLINDERS (2)
27	R22-427	FUEL TANK (specify color)
28	R22-428	SIDE RAILS (4) (specify color)
29	R22-429	REPLACEMENT MOTOR ONLY
30	R22-430	BELL
31	R22-431	TRUCK MOUNTING BLOCK (1)
32	R22-432	COUPLER MOUNTING BLOCK & PIVOT (1)
33	R22-433	AIR HOSES (1 right and 1 left)
34	R22-434	COUPLER LIFT BAR w/ 4 HOLDERS (1)
35	R22-435	SINGLE AIR HOSE
36	R22-436	LIGHT BULB AND WIRE (cab)
37	R22-437	LIGHT BULB AND WIRE (number board)
38	R2021	SNOW PLOW (1)
	R50001	USA TRAINS SMOKE FLUID
	R50002	USA TRAINS CONDUCTIVE LUBRICANT

**FOR SERVICING AND LIMITED ONE YEAR WARRANTY INFORMATION,  
PLEASE REFER TO THE WARRANTY CARD PROVIDED WITH THE LOCOMOTIVE**

**Please call our parts department for prices and availability or visit our  
web site [www.usatrails.com](http://www.usatrails.com) • Phone: 781-322-6084 • Fax: 781-321-6459**

## OPERATION

### POWER REQUIREMENTS

The locomotive is designed to operate on direct current (DC) with outputs of 0-22 volts.

### CONTROL SWITCHES

The locomotive contains four switches to operate the on/off motors, on/off smoke generator, on/off lights and on/off sound. The control switches are located on the underside of the locomotive, between the front motor truck and the fuel tank. (see diagram below)

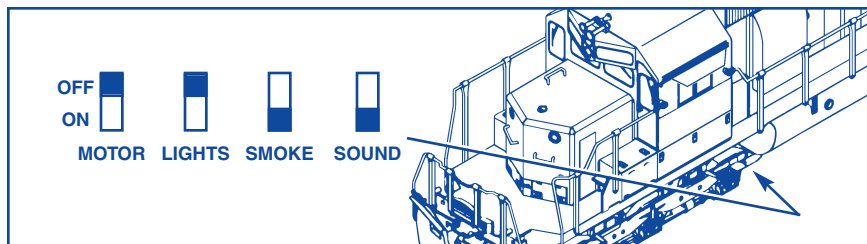

**CAUTION!** If the locomotive is going to be run for any period of time without smoke fluid, please position the smoke switch to the OFF position.

### SMOKE GENERATOR

The locomotive contains a fan driven smoke unit which produces "diesel exhaust" through the stack on the topside of the cab body. The smoke generator requires the periodic addition of smoke fluid in order to operate properly. To add smoke, remove the stack from the top of the locomotive and add 25-30 drops of USA Trains smoke fluid (USA Trains part # R50001) into the smoke generator hole. Never overfill the smoke generator and promptly wipe up any excess smoke fluid that may have spilled onto any painted surfaces. Place the smoke stack back on top of the locomotive and begin operation. Smoke production will begin when the fluid becomes heated. It may take longer to generate the smoke if the unit is full. When the smoke chamber is empty the unit will shutdown automatically until more fluid is added. By following these directions the smoke generator will provide hours of enjoyment and enhance the realistic operation of your SD40-2 locomotive.

**CAUTION!** Even though your locomotive is equipped with an automatic shut-off when the smoke generator runs out of fluid, we suggest you shut off the smoke switch on the underside of the locomotive to prevent accidental burning out of the smoke generator.

## ASSEMBLY

Due to the high level of detail designed into the USA Trains SD40-2, some simple assembly is required.

### (1) M.U. Connectors (2)

Insert M.U. connector in frame as shown in diagram below. (both ends)

### (2) Fold Down Step (2)

Insert step into step base assembly and insert into end of frame as shown in diagram below. (both ends)

### (3) Coupler Lift Bar Assembly (2)

Insert 2 eye bolts onto each side of lift bar and insert all 4 eyebolts onto frame as in diagram below. (both ends)

### (4) Air Hoses (6)

Insert right and left air hoses (3) into frame and single air hose to right of coupler as shown in diagram below. (both ends)

### (5) Hand Rails - Sides and Ends (6)

Insert side and end handrails into frame as shown in diagram below.

### (6) Smoke Stack

Insert (1) plastic stack into smoke stack hole as shown in diagram below.

### (7) Optional Snow Plow (2)

Two snow plows are provided for each pilot of this locomotive. For the end (or both ends) that requires coupler operation do not use "knock out portion" of plow to allow the coupler arm to swing freely on curves. Insert snow plow into 4 holes on each end of locomotive.

**NOTE:** For layouts with inclined track some trimming of the snow plow bottom may be necessary to avoid the plow hitting the track rail.

